

Partition rooms flexibly. Protect personal privacy.

ropimex® Screen-Systems

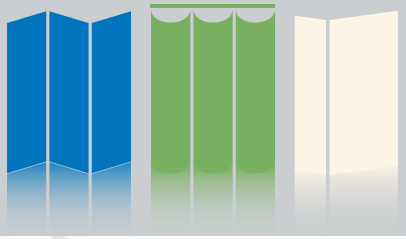

About us



Satisfied customers all over the world

Since 1976, ropimex® has been busy finding solutions to protect the privacy of the sick and those in need of care.

The telescopic screens of the early years are still in use today. From them a system developed, whose diversity, use and combination options provide a suitable solution for each and every customer.

ropimex® products made of anodised aluminium and high-quality glass-fibre reinforced plastics guarantee an extremely long life.

ropimex® products are lightweight and nonetheless robust. Easy handling, care and disinfection. The timeless, very attractive design fits in with every room.

The system is not only functionally perfected, it also satisfies the visual standards of the most modern furnishings in the health sector. All these properties, top advice from authorised stockists and the fastest possible delivery have secured ropimex® more than 75,000 satisfied users to date, all over the world.



ropimex® products conform to the highest safety standards. The telescopic screens including the trolley, the Vario rail system and the folding screens all bear the GS tested safety mark issued by the German TÜV (technical inspectorate).



Other business segments of
ROPILEX R. OPEL GmbH

DECOBA Wall protection systems

Adexano Hygiene systems



Contents

Telescopic screens, Telescopic arms

Application examples:..... 4 - 9
 Technical data: 10 - 13

Shower splash guard

Application examples:..... 14
 Technical data: 15

Telescopic screen cubicles

Application examples:..... 16 - 19
 Technical data: 20 - 21

Mobile screens

Application examples:..... 22 - 23
 Technical data: 24 - 25

Paravents

Application examples:..... 26 - 27
 Technical data: 28 - 31

Folding screens

Application examples:..... 32 - 35
 Technical data: 36 - 37
 Colours and designs:..... 38 - 39

Vario rail system

Application examples:..... 40 - 41
 Technical data: 42 - 43

Partitions

Application examples:..... 44
 Technical data: 45

Curtains

Trevira®CS, Cleanique
 staph CHEK®, ropirel® 46 - 47

For your safety

Certificates 48 - 49

Fabric sample cards 50

Telescopic
screens



RTS

swing-out



ropimex® swing-out telescopic screens

You can't trip over things that hang on the wall. Which is why we created ropimex® telescopic screens, the screen that's only there when it's needed.

After use, simply push the screen together and turn it towards the wall. Your room is back to looking its familiar self.

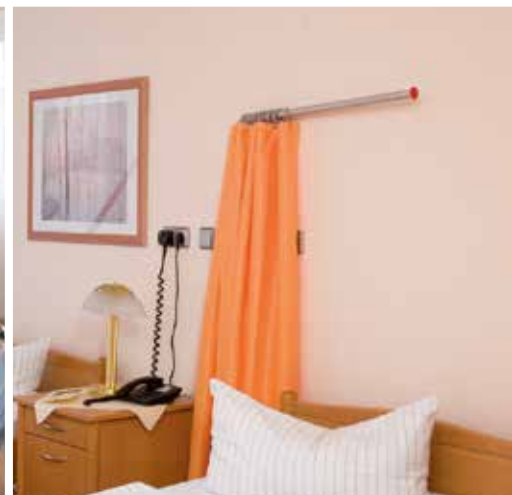

RTS models in the doctor's surgery

RTS models in the retirement and care home

One telescopic screen can be used to screen off several beds, which have been previously fitted with brackets

ropimex®

Telescopic
screens



RTI

fold-down and
swing-out





ropimex® telescopic screens, fold-down and swing-out

Ideal for intensive care units and all places where the telescopic screens cannot be swung to the side. After use, simply push together and fold down.



RTI models in the multi-bed room and on the intensive care unit
One telescopic screen can be used to screen off several beds, which have been previously fitted with brackets

Telescopic
screens



RTH

Telescopic arms
with hooks
fold-down and
swing-out

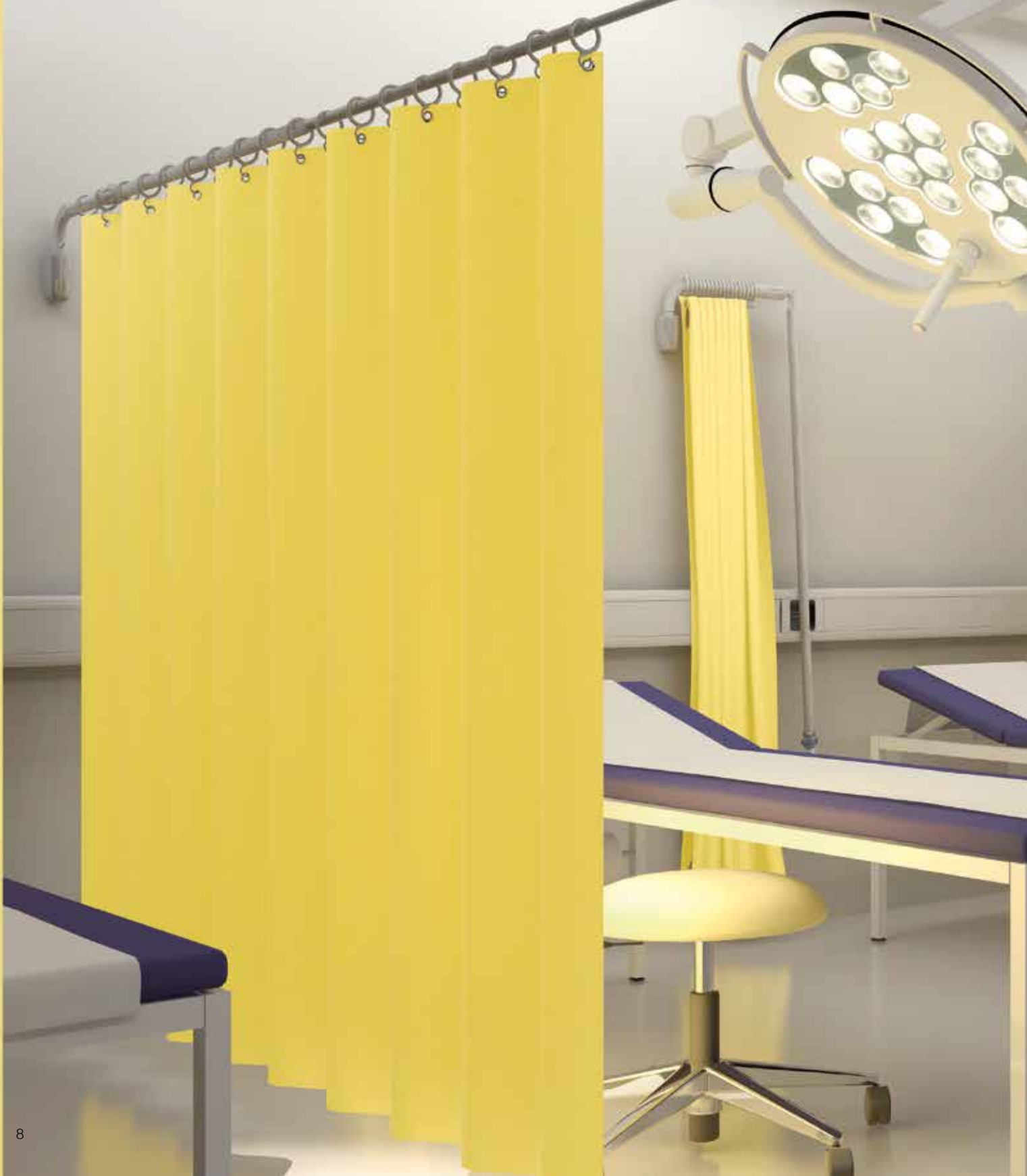



ropimex® telescopic arms, fold-down and swing-out

Used in combination with a height-adjustable ceiling mount RST or with an end support (GL), with the longest telescopic arm RTH 350 you can achieve a screen length of 350 cm. With the RTH models and the ceiling mounts you can divide up any room just how you want it.

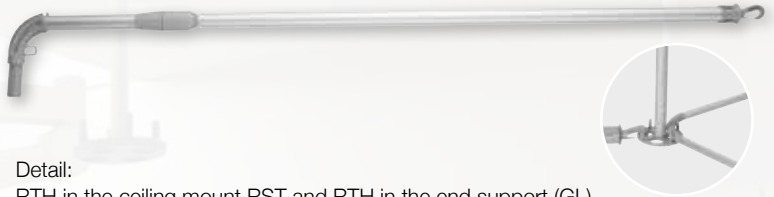

Detail:
RTH in the ceiling mount RST and RTH in the end support (GL)



If the GL cannot be mounted, e.g. on the window, a ceiling mount is used

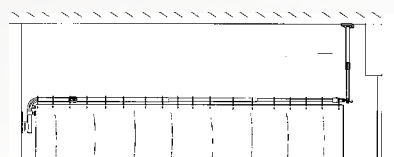
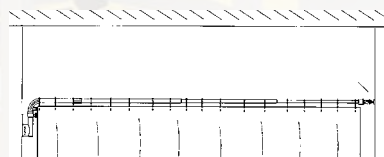

Telescopic screens

RTS, RTI
self-supporting*

Technical data



Material

ropimex® telescopic screens are made of anodised aluminium, high-quality, glass-fibre reinforced plastics. Easy to clean and to disinfect.



RTS: swing-out telescopic screen

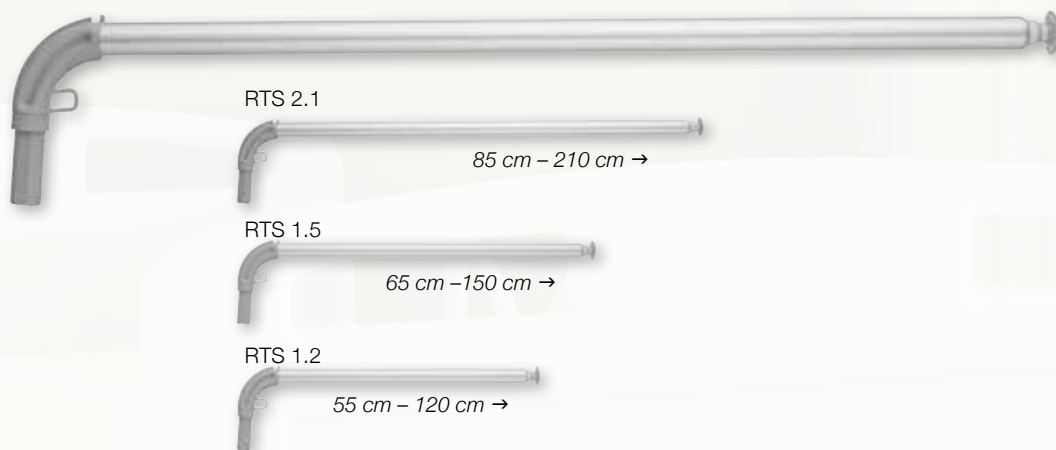

Model	Telescopic screen extension	Weight	Rings	Recommended curtains (see p. 46-47)
RTS 1.2	120 cm	0.5 kg	10	TCS 121, TCS 122, TCS 123, VH/C 121, VH/C 122
RTS 1.5	150 cm	0.6 kg	13	TCS 151, TCS 152, TCS 153, VH/C 151, VH/C 152
RTS 2.1	210 cm	0.7 kg	17	TCS 211, TCS 212, TCS 213, VH/C 211, VH/C 212

VR: Curtain rings

ropimex® curtain rings are always included with telescopic screens, telescopic arms and telescopic screen cubicles. Curtain rings can also be supplied separately. Standard colour: grey.



If they are loaded they release themselves from the eyelets of the curtains and therefore avoid injuries and damage to the system.

Colours: grey, violet, green, blue, yellow and white.



*freitragend: keine zusätzliche Fixierung an Decke oder gegenüberliegender Wand erforderlich

RTI: Telescopic screen, fold-down and swing-out

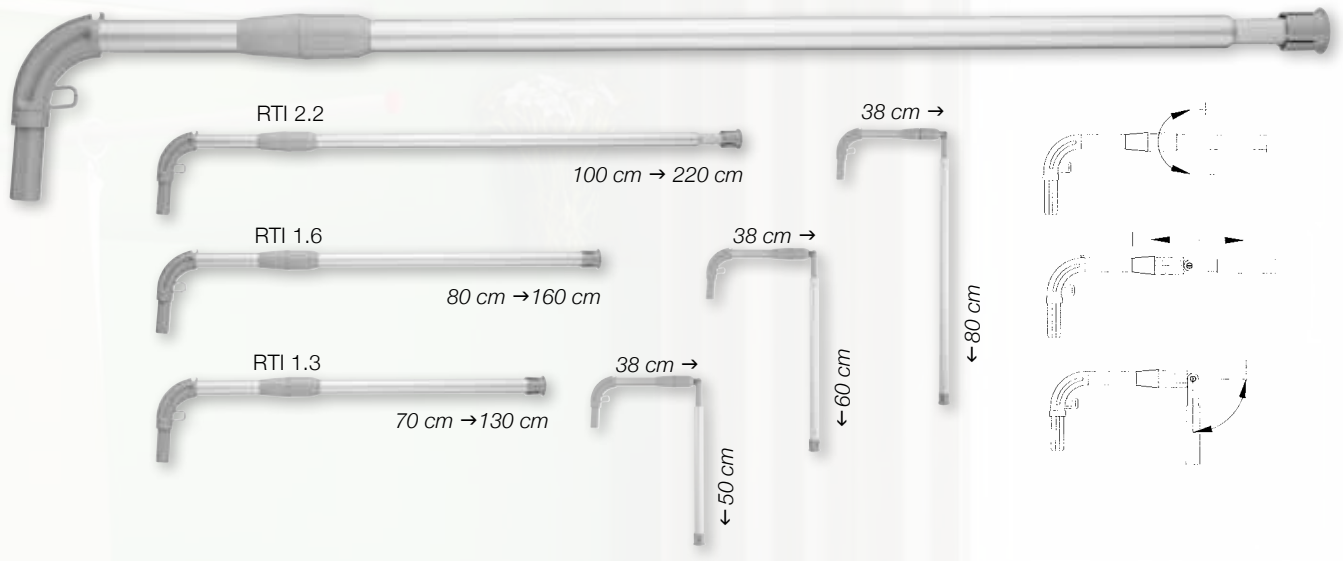

Model	Telescopic screen extension	Weight	Rings	Curtains (see p. 46-47)
RTI 1.3	130 cm	0.6 kg	10	TCS 121, TCS 122, TCS 123, VH/C 121, VH/C 122
RTI 1.6	160 cm	0.7 kg	13	TCS 151, TCS 152, TCS 153, VH/C 151, VH/C 152
RTI 2.2	220 cm	0.8 kg	17	TCS 211, TCS 212, TCS 213, VH/C 211, VH/C 212



Open and close fixable joints with half-turn.

RIA: Infusion arms (not telescopic)

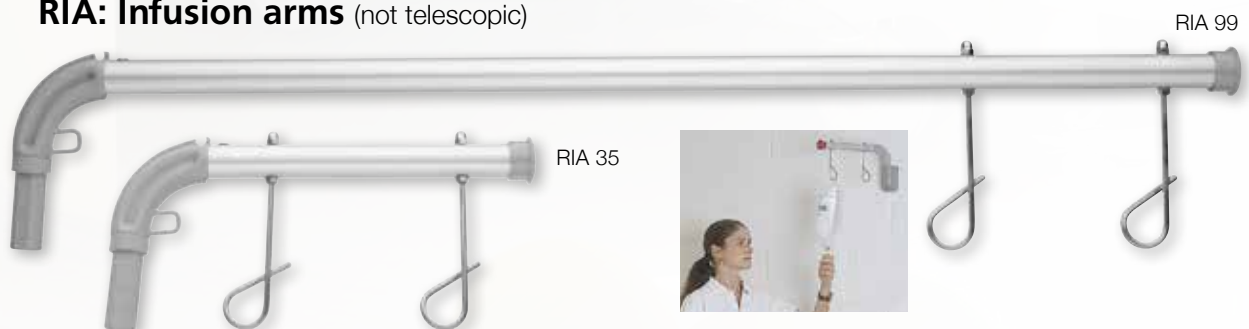

Model	Projection	Weight	Hook	max. load
RIA 99	100 cm	0.50 kg	2	1.25 kg per hook
RIA 35	35 cm	0.35 kg	2	4.00 kg per hook

RIA 35 in the telescopic screen holder "GSH/F"



Telescopic arms Ceiling mounts Brackets



RTH
not self-supporting
RST
WH, GSH

Technical data



RTH: Telescopic arms with hook, fold-down and swing-out

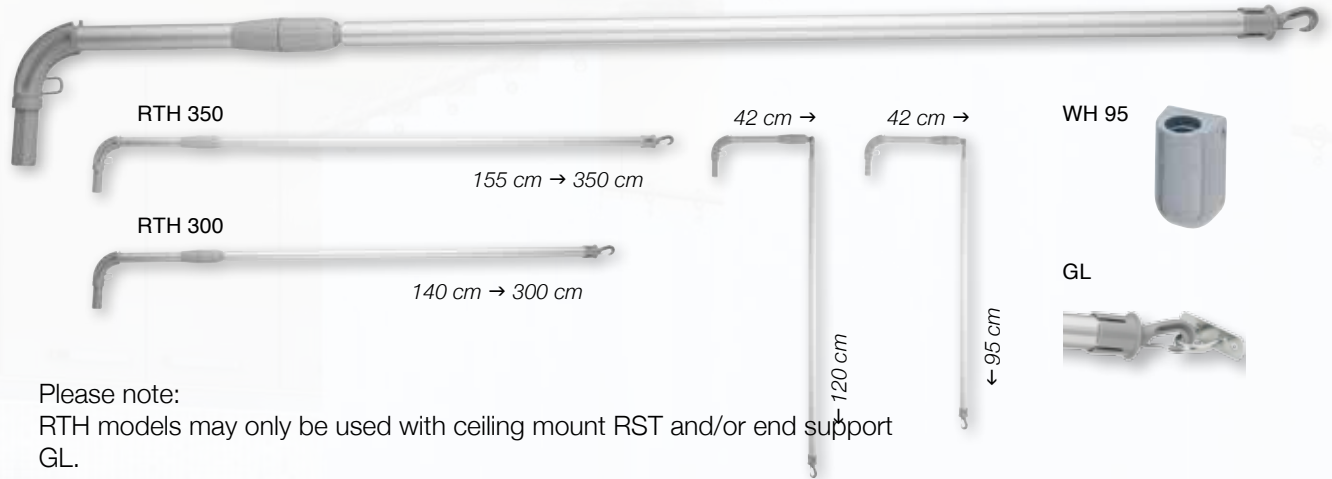

Please note:

RTH models may only be used with ceiling mount RST and/or end support GL.

Model	Telescopic screen extension	Weight	Rings	Curtains	Wall mount
RTH 300	300 cm with hook at the distal end	1.0 kg	25	TCS 330	WH 95 with end support GL
RTH 350	350 cm with hook at the distal end	1.1 kg	30	TCS 390	WH 95 with end support GL

RST: adjustable ceiling mounts

Model	Extension	Room height
RST 4	45 - 75 cm	245 - 275 cm
RST 8	75 - 135 cm	275 - 335 cm
RST 10*	110 - 200 cm	310 - 400 cm

*not illustrated
*ohne Abbildung

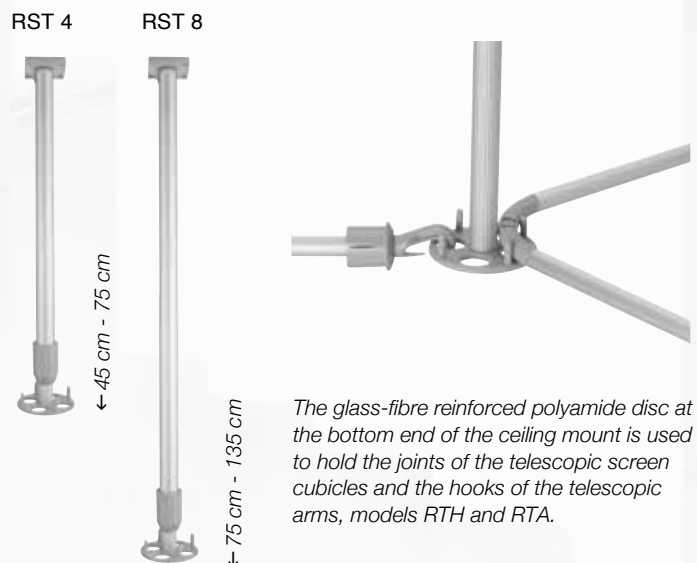

The glass-fibre reinforced polyamide disc at the bottom end of the ceiling mount is used to hold the joints of the telescopic screen cubicles and the hooks of the telescopic arms, models RTH and RTA.

WH: Wall brackets for telescopic screens

WH 95



WH



WH/LA



WH/F



WH/D



Model		Dimensions
WH 95	Wall mounting for all telescopic screens, die-cast aluminium, concealed screws, adjustable to compensate for unevenness of the wall, colour coated, colours: white (RAL 9010), signal grey (RAL 7004)	Height 10.0 cm, width 6 cm
WH	Wall mounting for all telescopic screens	Height 16.5 cm, width 6 cm
WH/LA	Wall mounting for bridging service ducts up to 15 cm	Height 16.5 cm, width 6 cm
WH/D	Wall mounting, height adjustable by 15 cm, especially suitable for shower splash guard	Height 35.0 cm, width 8 cm
WH/F	Wall mounting with knurled thumb screw	Height 16.5 cm, width 6 cm

GSH: Telescopic screen brackets for equipment rails

GSH/F



GSH/N



GSH/DK



GSH/95



GSH/V



Model		Dimensions
GSH/F	Telescopic screen bracket for equipment rail 25/10 mm, fixing by means of clamping screw	Height 13.5 cm Width 4 cm
GSH/N	Telescopic screen bracket for equipment rails, wall-supported, height-adjustable	Height 55 cm Width 5 cm
GSH/DK	Telescopic screen bracket with "double clamp" for equipment rails, height-adjustable	Height 55 cm Width 5 cm
GSH/95	Telescopic screen bracket for equipment rails, adjustable tilt	Height 10 cm Width 6 cm
GSH/V	Telescopic screen bracket for vertical tubes, max. 38 mm tube diameter, adjustable tilt	Height 10 cm Width 13 cm

Shower
splash guard

RDSE, RDTE,
RDLE



ropimex® Shower splash guard



Privacy screen for patients, splash guard for the care personnel.

The shower splash guard saves the care personnel having to get changed and therefore makes their work easier. One splash guard can be used for several shower areas fitted with wall brackets.

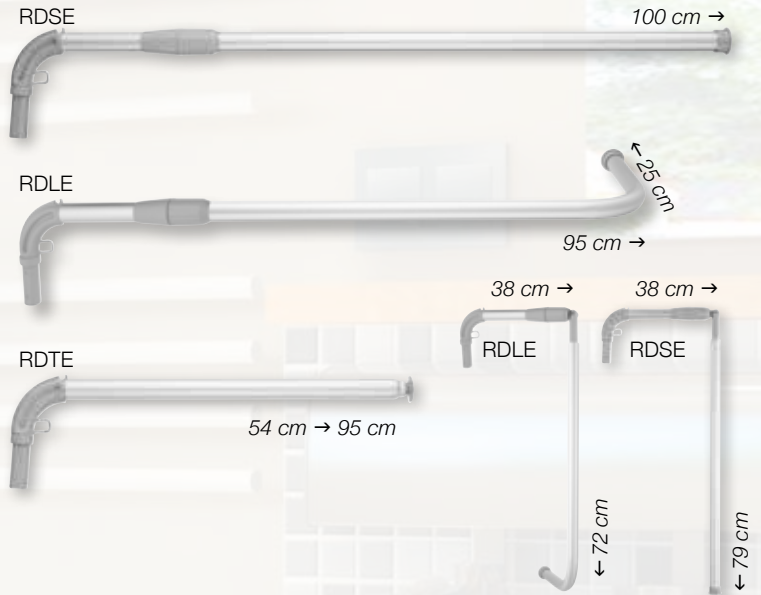

Model		Projection	Recommended curtains	Rings
RDSE	Splash guard arm swing-out and fold-down	100 cm	VH/C 100, CQ 108	10
RDTE	Splash guard arm, telescopic swing-out	95 cm	VH/C 100, CQ 108	10
RDLE	Splash guard arm, L-shaped, can be used on the right and left-hand side, side leg 25 cm, swing-out and fold-down	95 cm	VH/C 120, CQ 128	10
Wall mount	Recommended wall mount: WH, WH/D, WH 95 (for a description see p.13)			
Curtains	Recommended curtains: VH/C staph CHEK®, CQ Cleanique (see p.46/47)			
VR	ropimex® curtain rings are always included with our telescopic screens, telescopic arms and telescopic screen cubicles. Colour: grey.			

Telescopic
screen
cubicles



RKL

Telescopic screen
cubicles
(wall fixing)

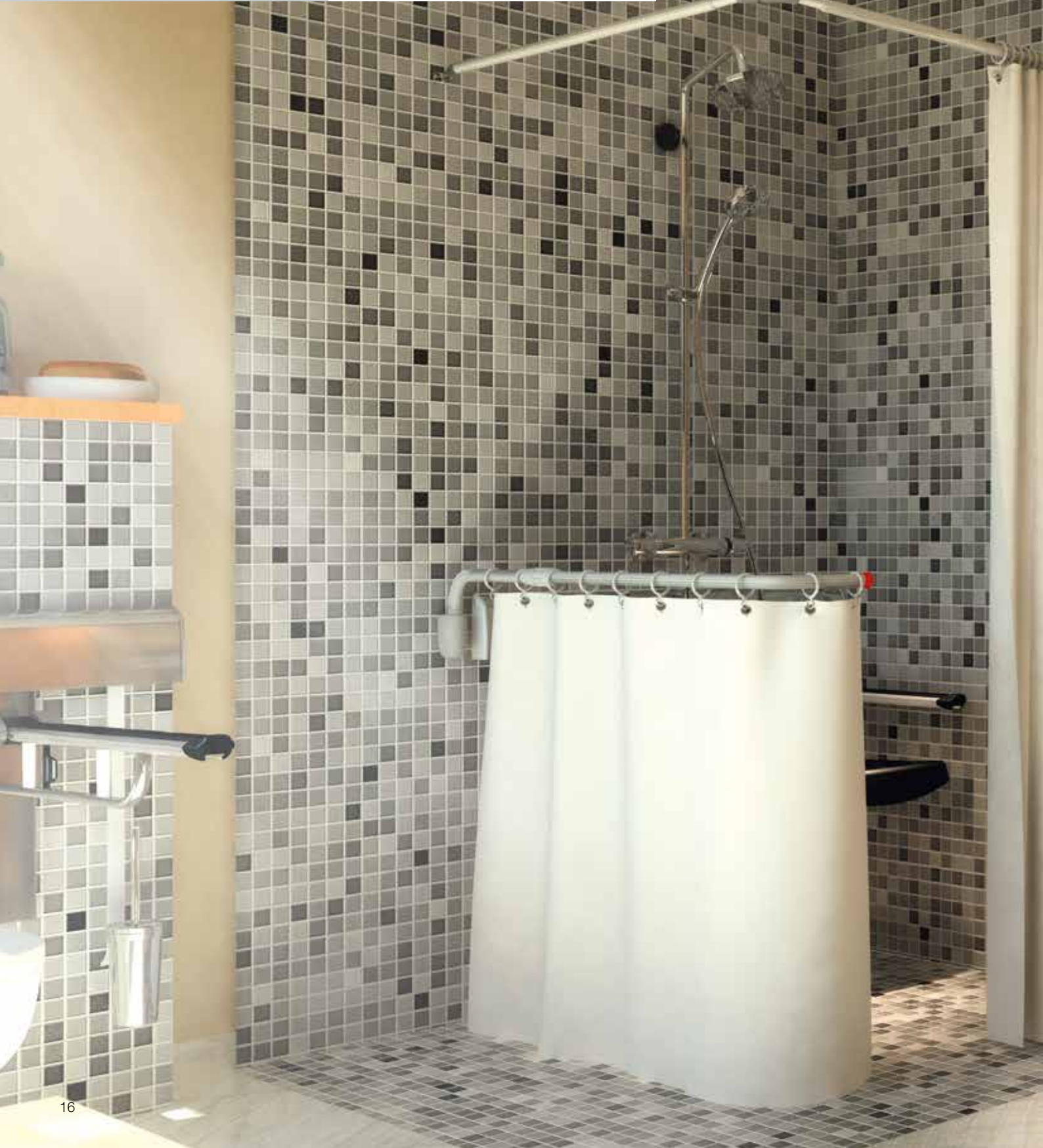

ropimex® Telescopic screen cubicles (wall fixing)

With this space-saving model it takes just a few seconds to create a screen for washing, changing, radiotherapy or inhaling, either as a corner solution or as a U-shaped solution.

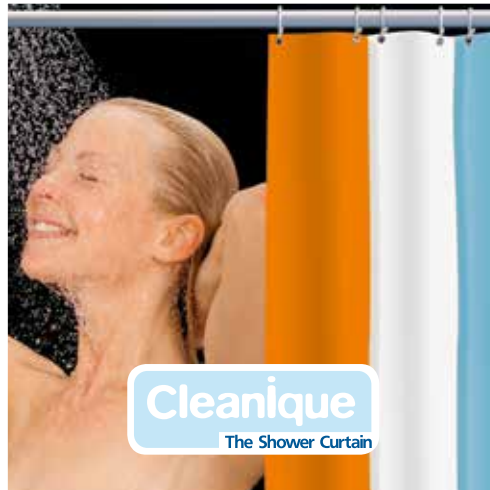

Cleanique
The Shower Curtain

ropimex® shower curtains:

Cleanique®



staphCHEK®



RKLE 1212 as washing area screen in parked position

RKLE 1212 as changing cubicle with telescopic arm RKAE 1.2
(U-shaped solution - 2 x wall mount "WH/F" required)

Telescopic
screen
cubicles



RKS

Telescopic screen
cubicles
(wall and ceiling
mounting)



ropimex® Telescopic screen cubicles (wall and ceiling fixing)

The large version RKS 2822 provides 6 m² of screening. Ideal for multi-bed rooms and treatment rooms. The height-adjustable RST ceiling mounts provide stabilise the cubicles and enable several cubicles to be lined up side-by-side.

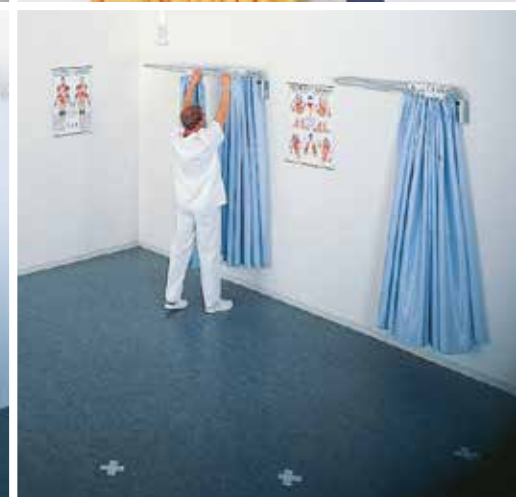

- RKS in RST
- RKS in parked position
- RKS as side-by-side cubicle
- Create space, e.g. for group therapy

Telescopic screen cubicles



RKL, RKS

Technical data



RKL: Telescopic screen cubicles (wall fixing)

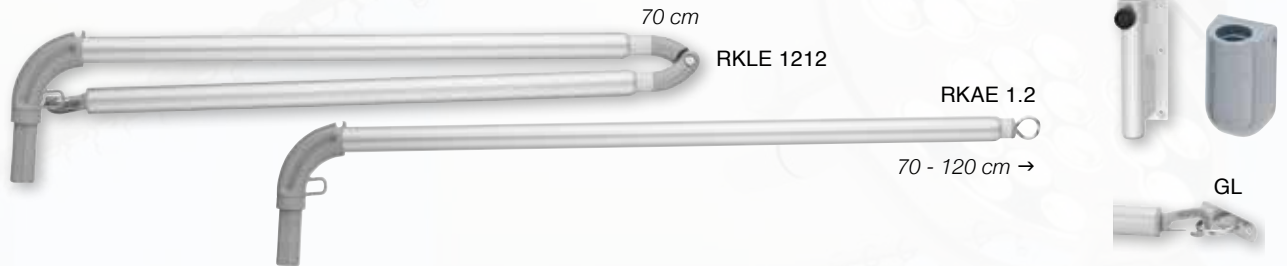

Model	Corner solution	Extension	Rings	Curtains	Wall mount
RKLE 1212	Telescopic screen cubicle	max. 120/115 cm min. 75/ 70 cm	22	TCS 217	WH/F, WH 95 with end support GL
RKLE 1515*	Telescopic screen cubicle	max. 150/145 cm min. 90/ 85 cm	30	TCS 330	WH/F, WH 95 with end support GL
U-shaped cubicle					
RKAE 1.2*	Telescopic arm, combined with RKLE 1212 to create a U-shaped cubicle 120/115/120 cm	120 cm	10	TCS 123	WH/F
RKAE 1.5	Telescopic arm, combined with RKLE 1212 to create a U-shaped cubicle 150/145/150 cm	150 cm	13	TCS 153	WH/F

Please note: 2 x wall mount WH/F is required for U-shaped solutions.
Special designs are possible up to the maximum dimensions 170/170 cm.

RST: Telescopic screen ceiling mounts

Model	Extension	Room height
RST 4	45 - 75 cm	245 - 275 cm
RST 8	75 - 135 cm	275 - 335 cm
RST 10*	110 - 200 cm	310 - 400 cm

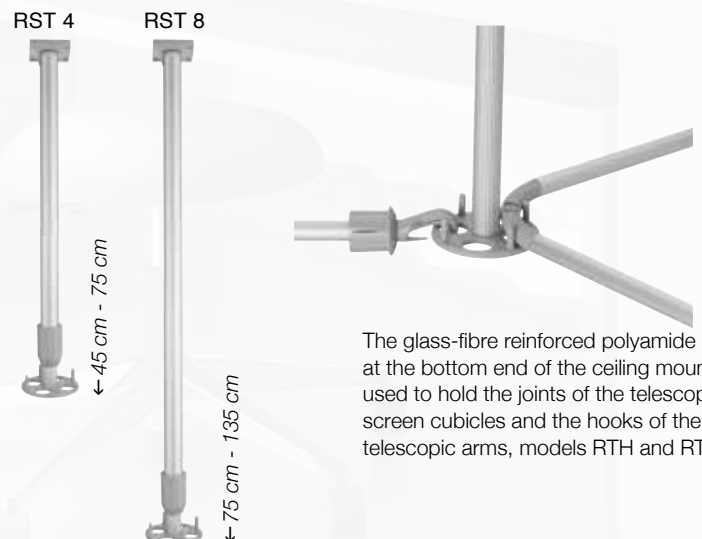

The glass-fibre reinforced polyamide disc at the bottom end of the ceiling mount is used to hold the joints of the telescopic screen cubicles and the hooks of the telescopic arms, models RTH and RTA.

*not illustrated

RKS: Telescopic screen cubicles (wall and ceiling fixing)



Model		Extension	Rings	Curtains	Wall mount
RKS 2822	Telescopic screen cubicle (Long side leg in WH 95)	max. 280/220 cm min. 110/ 90 cm	45	TCS 330 TCS 217	WH 95 with end support GL
RKS 2228*	Telescopic screen cubicle (Short side leg in WH 95)	max. 220/280 cm min. 95/110 cm	45	TCS 330 TCS 217	WH 95 with end support GL
RKS 2315*	Telescopic screen cubicle (Short side leg in WH 95)	max. 230/150 cm min. 110/ 85 cm	33	TCS 217 TCS 153	WH 95 with end support GL
RKS 1523	Telescopic screen cubicle (Short side leg in WH 95)	max. 150/230 cm min. 85/110 cm	33	TCS 217 TCS 153	WH 95 with end support GL

RTA: Telescopic arms (wall and ceiling fixing)



Model		Extension	U-shaped cubicle	Rings	Curtains	Wall mount
RTA 1.5	Telescopic arm, swing-out, with hook at the distal end	150 cm	U-shaped cubicle combined with RKS 1523	13	TCS 153	WH 95 with end support GL
RTA 2.3	Telescopic arm, swing-out, with hook at the distal end	230 cm	U-shaped cubicle combined with RKS 2315	20	TCS 217	WH 95 with end support GL
RTA 2.8	Telescopic arm, swing-out, with hook at the distal end	280 cm	U-shaped cubicle combined with RKS 2822	25	TCS 330	WH 95 with end support GL

Please note: The cubicle rails of the RKS series can only be used with ceiling mounts. An additional ceiling mount is required for U-shaped solutions using the RTA 1.5, RTA 2.3 or RTA 2.8 telescopic arms.

Mobile
screens

FG95



ropimex® mobile screen

The mobile screen '95 is ready to use in only a few seconds and is quickly returned to its parked position. Its smooth and easy movement, low weight and high degree of stability ensure simple handling.

The mobile screen, fitted with one or two telescopic screens, is ideal for mobile screening, e.g. for corridor occupancy, in multi-bed rooms, in the outpatients department or at the gynaecology chair.



Mobile screen '95 with one or two telescopic screens in use

Mobile screens



FG 95

Technical data



FG 95 trolley

Height of trolley: 155 cm →

Height of trolley with telescopic screen: 165 cm →

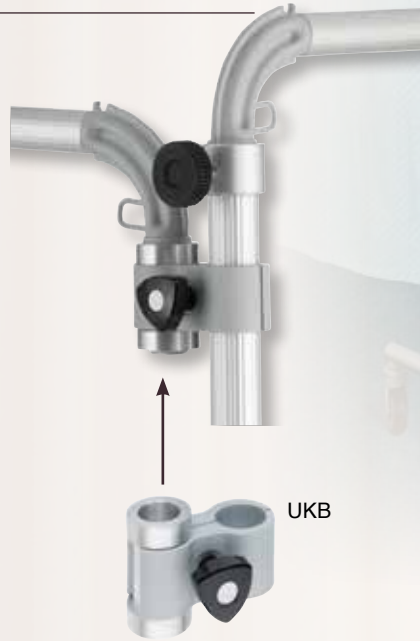

UKB

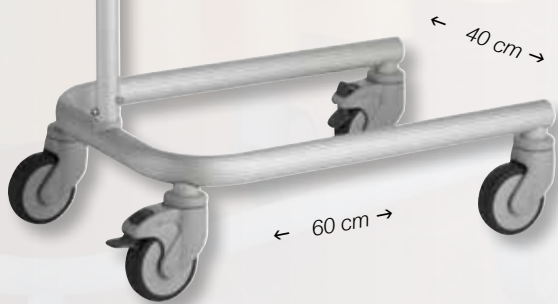

Model

FG 95

Trolley

155x60x40 cm (H/D/W), 4 castors \varnothing 100 mm, 2 of which are lockable. Aluminium anodised, glass-fibre reinforced polyamide, corrosion-resistant, disinfectable.

LA

Electrically conductive castors available for an extra charge.

UKB

Universal clamp for holding a second telescopic screen.

All telescopic screens in the "RTI" series can be used in the FG 95 trolley.



Mobile screen '95 with two telescopic screens

In parked position

Recommended telescopic screens for FG 95: RTI 2.2, RTI 1.6 and RTI 1.3

RTI 2.2

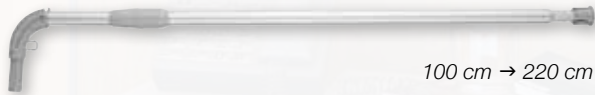

RTI 1.6

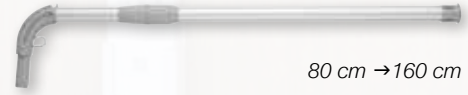

RTI 1.3



We recommend the following fitout:

Model	With one telescopic screen	Extension	Curtains
RTI 2.2	Telescopic screen, fold-down	220 cm	TCS 212, CQ 212
	With two telescopic screens	Extension	Curtains
RTI 2.2	Fold-down telescopic screen, (can only be used in the trolley, not suitable for the UKB clamp)	220 cm	TCS 212, CQ 212
RTI 1.3	Telescopic screen, fold-down	130 cm	TCS 122, CQ 122
RTI 1.6	Telescopic screen, fold-down	160 cm	TCS 152, CQ 152
UKB	Universal clamp for use of a second telescopic screen, telescopic screens: RTI 1.3, RTI 1.6		

Paravents

RLP

Lightweight
paravents





ropimex® Lightweight paravents are convincingly easy to handle.

The 360° non-see-through hinges each leaf enable each leaf to be moved into the required position.

Standard fabric covering with staph CHEK® fabric, with Trevira®CS for an additional charge.



*Standard version without castors.
Can be supplied with castors for an additional charge.*

Please note: Paravent leaves must always be positioned at an angle to each other, unless the ropimex® base (model RLP/C) is used.



Lightweight paravent RLP/4 in retirement and care home

Folded together, a storage space can be found anywhere

Base for stabilising a single or several paravents to make use of the open width or to form a routing system

Butterfly paravent, mobile, ideal for screening the bottom ends of beds

Paravents

RLP
RLP/C

Technical data



RLP



*Covering: without folds.
Opaque 360° hinges.*



*Standard version without castors.
Models RLP/3 and RLP/5 can be
supplied with castors for an extra
charge.*

RLP/C base to stabilise the paravent



Base for holding up to 4 paravents



1 paravent at right-angles

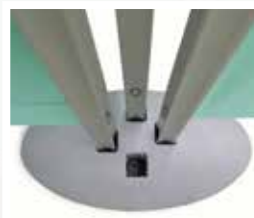

3 paravents in the base



4 paravents in the base



2-leaf paravent in the base



Paravents in a row as a routing system



Leaf-wise colour selection also possible.

Model	ropimex® lightweight para-vent	Leaf	Weight	Width	Height
RLP/2	Lightweight paravent, 2-leaf	2	3.8 kg	100 cm	165 cm
RLP/3	Lightweight paravent, 3-leaf	3	5.7 kg	150 cm	165 cm
RLP/4	Lightweight paravent, 4-leaf	4	7.6 kg	200 cm	165 cm
RLP/5	Lightweight paravent, 5-leaf	5	9.5 kg	250 cm	165 cm

Material	Frame: Aluminium design profiles, natural-anodised, foot and cover caps made of polyamide, light grey. Optional: Plastic castors, black
Covering	Standard covering staph CHEK®. staph CHEK® fabric is antibacterial, flame-resistant, self-extinguishing, antistatic and durable. It does not have to be washed. Stains are easily wiped off with a sponge and household cleaning products.
Colours	light blue, white, yellow, beige, mint

Available with Trevira®CS covering for an extra charge.

Model	ropimex® base		
RLP/C	Base to stabilise the paravent when opened out straight (use of the open width) and/or for holding several paravents (max. 4 per base), as a partition or for setting up a routing system		
Material	Glass-fibre reinforced polyamide (GRP)		
Dimensions/Weight	8 x 15 x 30 cm (H x W x D), weight 1.3 kg		
Variations	1 Paravent in a line	1 Paravent at right-angles	up to 4 paravents possible

Paravents

RBP
RLP/W

Technical data



RBP Butterfly-Paravent



Butterfly paravent in parked position

RLP/W for wall-mounting



- Accessories available:
- Clamp set for service rail
 - Spacer for wall fixing
 - Upright made of stainless steel



Model	ropimex® butterfly paravent
RBP	3-leaf, with middle leaf centred on double T-leg and 360° rotatable leaves on either side, fold-away
Dimensions	Leaf widths 45/50/45 cm, height 165 cm, weight 8.9 kg

Material	Frame: Aluminium design profiles, natural-anodised, foot and cover caps made of polyamide, light grey. Plastic castors, black
Covering	Standard covering staph CHEK®. staph CHEK® fabric is antibacterial, flame-resistant, self-extinguishing, antistatic and durable. It does not have to be washed. Stains are easily wiped off with a sponge and household cleaning products.
Colours	light blue, white, yellow, beige, mint

Available with Trevira®CS covering for an extra charge.

Model	ropimex® lightweight paravent with wall connector	Leaf	Weight	Width	Height
RLP/W2	with wall connector, on castors	2	3.8 kg	100 cm	165 cm
RLP/W3	with wall connector, on castors	3	5.7 kg	150 cm	165 cm
RLP/W4	with wall connector, on castors	4	7.6 kg	200 cm	165 cm
RLP/W5	with wall connector, on castors	5	9.5 kg	250 cm	165 cm

Accessories

RLP-WA	Spacer for wall fixing, standard spacing 100 mm, special length to customer-specified dimensions possible up to 400 mm
RLP-KLS	Clamp set for fixing to double-track standard rail
RLP-ES	Upright made of stainless steel for RLP/W, for free-standing installation in the room, height 1,650 mm

Folding
screens



RFW

wall-mounted





ropimex® folding screen

Well-designed and elegant, the folding screen protects the privacy of your patients.

Flexibly usable as a screen or partition in the hospital and care sector, the robust and impact-resistant folding screen is positioned in seconds and parked back against the wall after use. The number of leaves can be extended at a later date. Non-see-through but translucent leaf infill material with high-quality aluminium profile creates a pleasant, light atmosphere.

Modern leaf designs, available in different colours, give the folding screen an individual touch.



Can be mounted on the wall or on service rails by means of holders

Flexible in all directions

Can be folded together to save space

Also available as a free-standing upright solution

Folding
screens



RFW-FG

mobile





ropimex® Mobile folding screen

the classic example of adaptability and versatility.

Mobile folding screens, which are used here today and there tomorrow, offer the greatest possible spatial flexibility in everyday care and treatment work: in hospitals and care of the aged, in doctors' surgeries as well as in clinical rooms. At the same time you guarantee patients the necessary discretion.

Position, fold open, fold together after use and roll away – care of the easy-clean surfaces made of aluminium and scratch-resistant polycarbonate is just as easy as the handling.

Visually the design award-winning folding screens contribute to the general feeling of well-being – in the doctor's surgery or in a clinic.



RFW-FG in parked position

RFW-FG for the children's ward

Butterfly-Faltwand RBF mit Flügelbreiten 45/50/45 cm, Höhe 165 cm
geschlossen, geöffnet und in S-Form

Folding screens



RFW

Technical data

RFW for wall-mounting



Non-see-through 360° hinges.

The RTC unit (rop-imex®-Turn&Connect) enables 360° leaf rotation.

Accessories available:
Clamp set for service rail
Spacer for wall-mounting



RFW-FG mobile



Note: Mounted on a trolley, the folding screen is only mobile. It is therefore not possible to convert it to a wall-mounted screen or to fix it to an equipment rail or column.

Well-designed and stable

RFW-ES stainless steel column for folding screen



Stainless steel column



Stainless steel column can be fitted with max. 4 folding screens



ropimex®-Folding screen RFW: for wall-mounting, mobile or as a free-standing upright solution

- Pleasant atmosphere due to non-see-through but translucent leaf infill material made of polycarbonate
- Space-saving, fold-away and ready for use again in seconds
- Screen length longer than 300 cm possible
- 3 heights to choose from
- From 3 to 10 leaves possible
- RTC (ropimex® Turn & Connect) enables leaf rotation up to 360°
- Can be extended at a later date

Model RFW	Folding screen for wall-mounting	Screen	open width
Leaf width	30 cm	3-leaf	90 cm
Heights	145 / 165 / 185 cm	4-leaf	120 cm
Weight	3.00 / 3.50 / 4.00 kg/leaf	5-leaf	150 cm
Frame	Frame and hinged profiles: extruded aluminium (Al Mg Si 05), anodised surface, connecting screws: V2A stainless steel	6-leaf	180 cm
Plastic parts	PA 6 GF 15, polyamide with 15% glass fibres	7-leaf	210 cm
Infill panels	Polycarbonate, 2 mm, white, translucent, flame resistant, con-struction material class B1, DIN 4102-01, extremely impact resistant	8-leaf	240 cm
Care	commercially available cleaning product and disinfectant	9-leaf	270 cm
		10-leaf	300 cm
RFW-WA	Spacer for wall fixing, standard spacing 100 mm, special length to customer-specified dimensions possible up to 400 mm		
RFW-KLS	Clamp set for fixing to double-track standard rail		

Model	Trolley for folding screen
RFW-FG	The mobile version with max. 10 leaves enables mobile use. Please note: mobile folding screens are available in heights 145 and 165 cm only.
RFW-FG4	Height 145 cm, weight 14 kg
RFW-FG6	Height 165 cm, weight 15 kg
Trolley base	52 x 59 cm
Folding screen	For description and screen length see above (RFW)

Model	Stainless steel column for folding screen
RFW-ES	Ideal wherever wall-mounting is not possible. Stainless steel column with dimensions 5 x 5 cm. Available in 3 heights.
RFW-ES4	Height 145 cm, weight 5.00 kg
RFW-ES6	Height 165 cm, weight 5.50 kg
RFW-ES6	Height 185 cm, weight 6.20 kg
Upright	5 x 5 cm
Folding screen	For description and screen length see above (RFW)

Folding screens



RFW

Colours and designs

Available in 10 colours and 5 design options



Request our special brochure: ropimex®-The folding screen



Standard: white translucent



020 golden yellow



015 yellow-orange



329 carnation red



017 cherry red



063 lime green



054 turquoise



053 light blue



074 blue-grey



081 copper-brown



Plain



Design Leaves



Retro Design available in 5 colours



Flowers Gingko available in 4 colours



Animals Design



Beetles Design

Plain



- Optional continuous or leaf-wise covering
- Standard colour: white, translucent
- Film overlay on both sides, translucent

Leaves design



- Can be combined leaf-wise with PLAIN
- Film overlay on one side
- The white-translucent polycarbonate enables the design to show through at the back
- Specify whether right or left-hung

Retro design



- Can be combined leaf-wise with PLAIN
- Film overlay on one side
- The white-translucent polycarbonate enables the design to show through at the back
- Specify whether right or left-hung



green blue copper yellow red

Ginkgo design



- Can be combined leaf-wise with PLAIN
- Film overlay on one side
- The white-translucent polycarbonate enables the design to show through at the back
- Specify whether right or left-hung



blue-grey yellow-orange cherry red lime green

Animals design



- Can be combined leaf-wise with PLAIN
- Film overlay on one side
- The white-translucent polycarbonate enables the design to show through at the back
- Specify whether right or left-hung

Beetles design



- Can be combined leaf-wise with PLAIN
- Film overlay on one side
- The white-translucent polycarbonate enables the design to show through at the back
- Specify whether right or left-hung

Vario
rail system

RVS



ropimex®-Vario rail system

One system – any number of options!
Slanting walls? Acute angle? No problem!
We supply wall connectors, which can be continuously adjusted up to 180 degrees – and compensate for virtually any asymmetry in the architecture.
Move or renovation: The rail system is designed to adapt to new requirements at any time.



Vario rail system RVS in the admissions department
Many shapes possible
If the curtains are overloaded they release themselves from the curtain eyelets
Mounting above the lintel

Vario rail system



RVS

Technical data



Colours

Profile tube: silver Eloxal,
Connector: grey, RAL 7004

Free-standing end:

End cap RVS/EK stops the curtain.

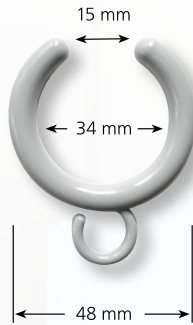

Curtain ring RVS/VR

Curtain ring made of unbreakable polyamide: Releases itself from the curtain eyelet if overloaded (approx. 2 kg).

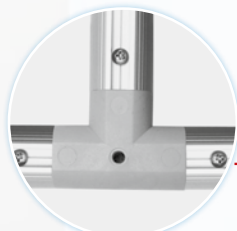

With T-connectors (RVS/TV) or cross-connectors (RVS/KV) you can create **cubicles to your own requirements.**

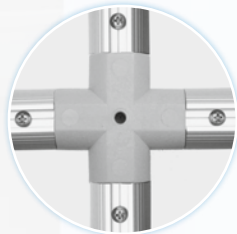

Sloped walls, acute angles:

the Vario wall connector RVS/WAV compensates for and levels out asymmetries up to 180° and length differences up to +/- 5 mm.

180°

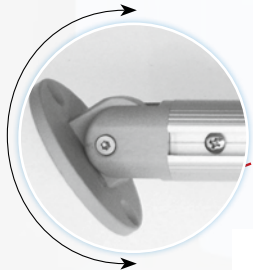

+/- 5 mm

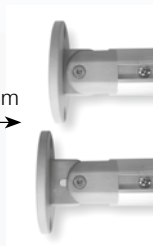

Easy ordering: A simple sketch suffices!

Simply prepare a hand-drawn, dimensioned sketch of the required room layout, enter the widths and lengths as well as the room height and the required headroom.

We will put together the complete system for you.

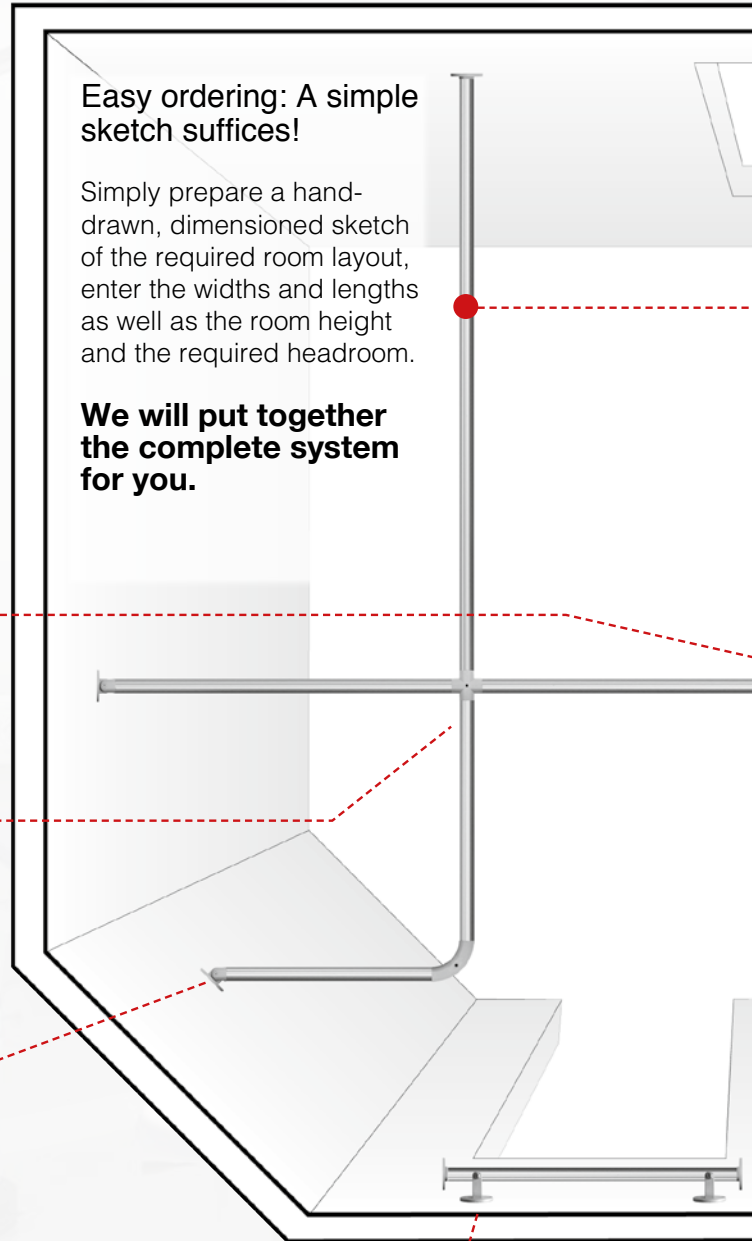

Easy above the lintel:
e.g. at windows or doors using the wall connector RVS/WAS

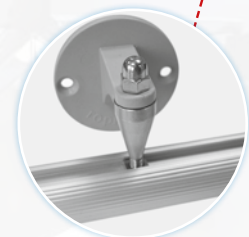



Straight at the wall:
Wall connector
RVS/WA

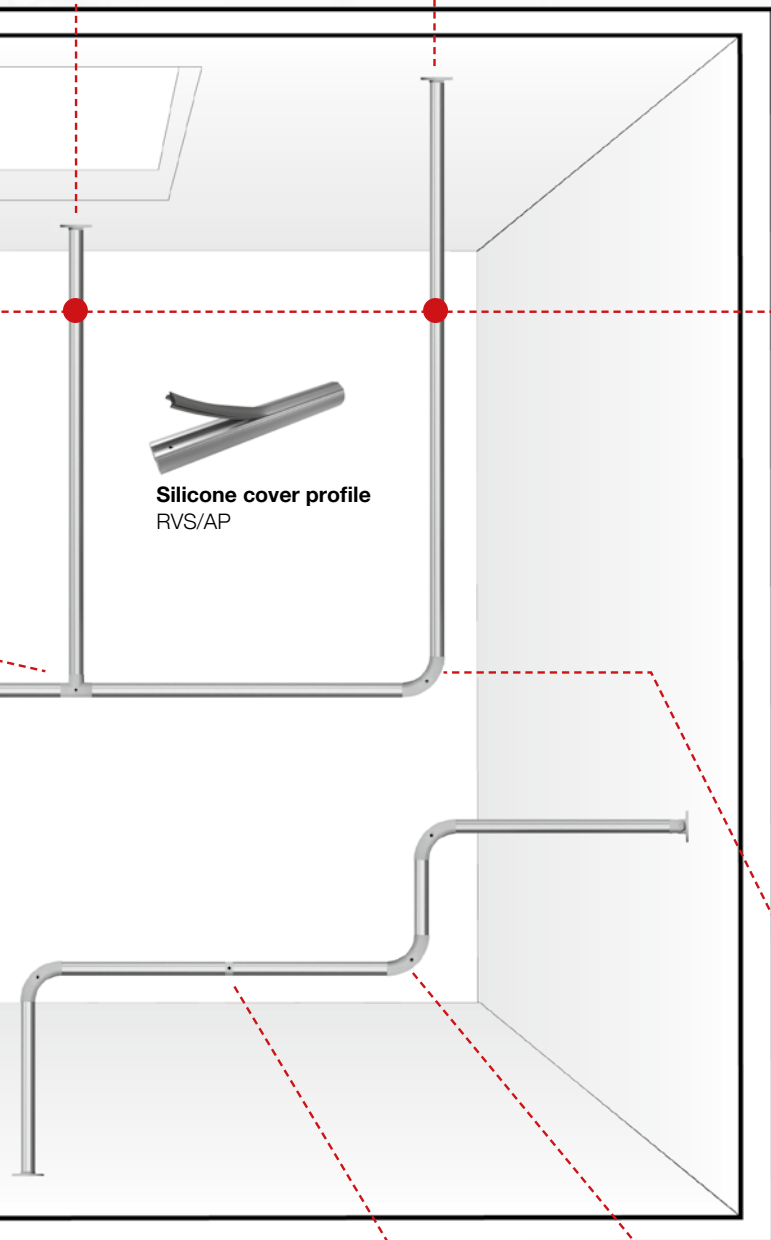

Silicone cover profile
RVS/AP

Ceiling connectors

Suspended at headroom height:
with the adjustable ceiling mount (+/- 20 mm) RVS/DS.

For free-standing end RVS rails:
adjustable double ceiling mount (+/- 2cm) RVS/DDS.

Mounted directly under the ceiling:
with ceiling bracket RVS/DH (distance from top of ceiling to bottom of rail approx. 6 cm).



Anchoring on profile rail: possible along the whole length by means of square nut; for adjustable ceiling mount RVS/DS or with ceiling bracket RVS/DH. Max. spacing: 2 m.



Or:

Anchoring via all connectors: Standard threaded hole for screwing in the adjustable ceiling mount RVS/DS or the ceiling bracket RVS/DH ensures firm support.

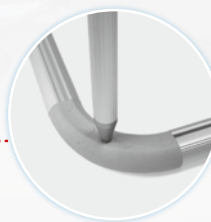

Change later: simply disconnect the profile tube and install the connector of your choice, e.g. linear connector RVS/LV

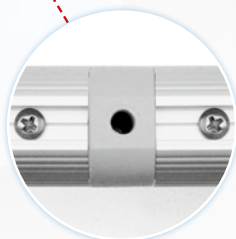

Corner solutions without sharp edges:

with the curved connector RVS/BV (radius 60 mm)

Daylight
partitions

RTW



flame
resistant



UV resistant

NEW!

Optimised infill panels



ropimex®-Daylight partitions

Modern treatment cubicles made to measure. Thanks to their neutrality the partitions fit in with any interior design and furnishings.



The combination of ropimex® daylight partitions with the telescopic system provides the unique opportunity for keeping windows accessible and fully functional.



Floor/
Ceiling mount



Connector



Wall connector



Variable curtain rail connections



Material

Impact resistant twin-wall panels with tongue and groove, antistatic, water and corrosion resistant, easy to clean with any household cleaner. The panels are UV-resistant and flame resistant. The frames are made of anodised aluminium profiles.

Curtain rails (RVS)

We supply curtain rails with accessories for the cubicle entrance areas. Please ensure that the curtain rails always overlap the front panels by approx. 20 cm. In this way the curtains close tight.

Curtains

We make the curtains in-house. We use flame resistant fabrics. They are fitted with eyelets and are made-to-measure. ropimex® curtains - see page 46-47.



Bridging of
e.g.
Service ducts



Attractive cover caps



Planning

We will definitely need a floorplan sketch for the production. The sketch does not have to be perfectly drawn or true-to-scale. Only the dimensions are important. Note any protrusions (radiators, pipes, etc.). Please draw them on and give dimensions. If fixing on the wall is not possible (e.g. because of a window), please state the room height. A floor support/ceiling mount is then required.

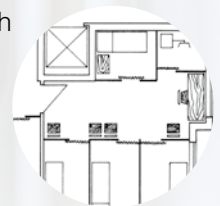

Curtains



Trevira®CS
Trevira®CS
Bioactive
staph CHEK®
Cleanique®
ropirel®



TCS ropimex® curtains made of Trevira®CS have been tried and tested for 20 years



Trevira®CS has passed every fire test worldwide and fulfils the fire test standards of all the important industrial nations.

The woven-in company logo ropimex® with the Trevira®CS label guarantee you this safety for ropimex® curtains.

Trevira®CS has an antibacterial effect. The physiological and dermatological properties are excellent. Trevira®CS Bioactiv is also **permanently** antimicrobial.

Curtains made of Trevira®CS are washable up to 60° C with disinfectant.

Size table

	Width	x	Height in cm
TCS 110	110	x	175
TCS 121	140	x	120
TCS 122	140	x	140
TCS 123	140	x	175
TCS 151	170	x	120
TCS 152	170	x	140
TCS 153	170	x	175
TCS 200	200	x	175
TCS 211	230	x	120
TCS 212	230	x	140
TCS 213	230	x	175
TCS 215	250	x	175
TCS 217	270	x	175
TCS 300	300	x	175
TCS 330	330	x	175
TCS 360	360	x	175
TCS 390	390	x	175
TCS 420	420	x	175
TCS 460	460	x	175
TCS 500	500	x	175

Available in 10 colours



lilac

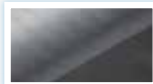

grey



sun yellow



melon



peach



light blue



white



light green



azur



champagne

Trevira®CS Bioactive

in 4 Farben lieferbar: weiß, hellgrün, hellblau und pfirsich.

RO ropimex®-BlackOut satinised fabric



Black-out fabric with 99% light blocking

- 100 % polyester, permanent flame-resistance: Fire class B1 to DIN 4102-1, flame-resistance is indelibly anchored in the molecular structure
- Soft feel, fine textile look
- Uncoated, both fabric sides the same. The blackout character is produced by a special fabric design.
- 30° C washable

Available in 7 colours



royal blue



azure



silver grey

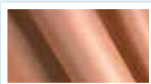

copper



gold



pale green

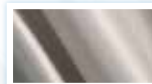

champagne

ropimex® curtains

Flame-resistant curtains can save lives!

CQ ropimex®-shower curtain - the new generation

Cleanique

The Shower Curtain



Top level hygiene:

thermoplastic polyether polyurethane with patented antibacterial and fungicidal active ingredient - provides lasting and reliable protection against contamination and mould, active antimicrobial effect

Fire safety classes: B1, DIN 4102, UL94 Class V0 (self-extinguishing),

lightfast, rub-resistant, tear-resistant, attractive drape, soft feel, seamless

Size table

	Width	x	Height in cm
CQ108	100	x	80
CQ128	120	x	80
CQ121	140	x	120
CQ122	140	x	140
CQ151	170	x	120
CQ152	170	x	140
CQ211	220	x	120
CQ212	220	x	140
CQ1218	120	x	180
CQ1220	120	x	200
CQ1420	140	x	200
CQ1620	160	x	200
CQ1820	180	x	200
CQ2020	200	x	200
CQ2220	220	x	200
CQ2420	240	x	200
CQ2720	270	x	200
CQ3020	300	x	200
CQ3320	330	x	200

Available in 3 colours

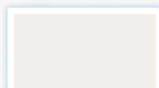

velvet-white

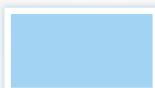

sky blue



orange

VH/C ropimex® curtains made of staph CHEK®

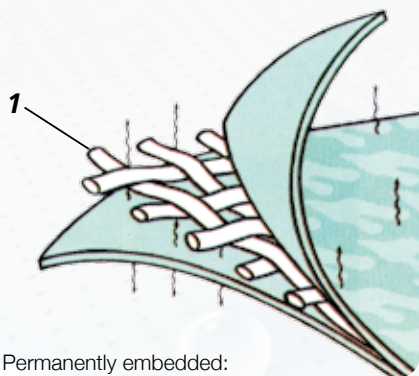

1. Permanently embedded:
active antibacterial components

staph CHEK®, the fabric for sanitary blocks, showers and bathrooms

This patented fabric is: antibacterial, flame resistant/self-extinguishing, antistatic, liquid-tight, kind to the skin, does not stick to the body when wet.

Stain and dirt repellent, durable. Mildew and mould spot growth prevented effectively.

Simply wipe off with a sponge and household cleaner.

Size table

	Width	x	Height in cm
VH/C 121	140	x	120
VH/C 122	140	x	140
VH/C 151	170	x	120
VH/C 152	170	x	140
VH/C 211	220	x	120
VH/C 212	220	x	140
VH/C 100	100	x	80
VH/C 120	120	x	80

Available in 5 colours



light blue

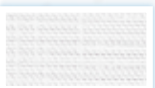

white

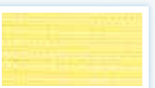

yellow



beige



mint

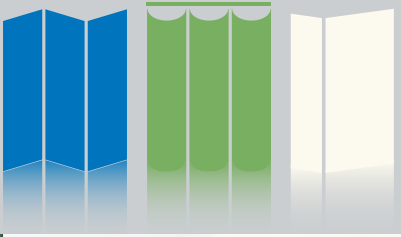

ropimex® products conform to the highest safety standards.

The telescopic screens including the trolley, the Vario rail system and the folding screens all bear the GS tested safety mark issued by the German TÜV (technical inspectorate).

ropimex® curtains made of Trevira®CS pass every fire test worldwide and are tested and certified to the Öko-Tex standard 100 Europe-wide.



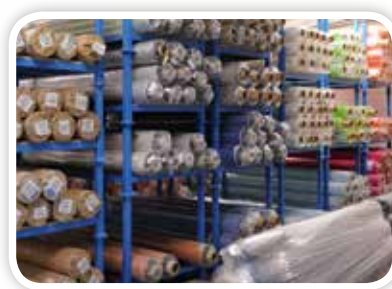

 **MADE
IN
GERMANY** ropimex® Screen systems since 1976

Fabric sample cards



Do you need a fabric sample card?
Just phone **0 68 21/9 12 77-0**
- we will send you what you need
without delay!



Catalogue 2016

Telescopic screens, Telescopic arms
Shower splash guard
Telescopic screen cubicles
Mobile screens
Paravents
Folding screens
Vario rail system
Partitions
Curtains

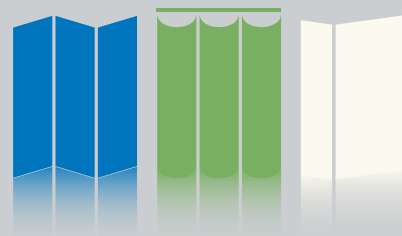

Partition rooms flexibly. Protect personal privacy.

ropimex® Screen Systems



www.ropimex.com



ROPIMEX R. OPEL GmbH
Bildstocker Str. 12-14 · D-66538 Neunkirchen · Tel. +49 6821 9 12 77-0
Fax +49 6821 9 12 77-99 · info@ropimex.com · www.ropimex.com

ropimex®